

# Data Sheet



Article number: 0105076

Description: Retaining ring AV 60

Note: Fitted with ZGA pliers

## Measures

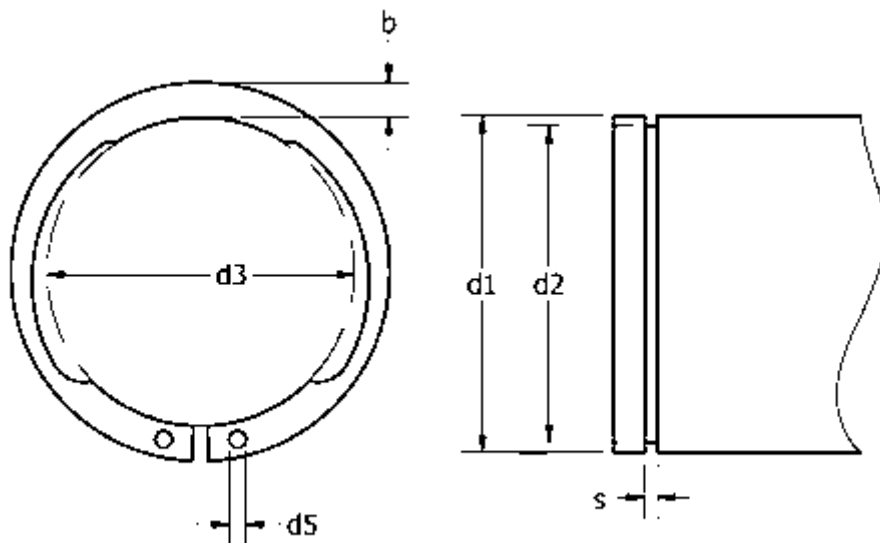

AN mm <sup>2</sup>	= 138.0	FRg kN	= 9.1	t	= 1.50
b	= 5.8	FR kN	= 55.5	tol	= -0.07
d1	= 60	g	= 2.5	tol	= -0.30
d2	= 57.0	K kN-mm	= 99.0	tol	= +0,46-1,10
d3	= 55.80	m min	= 2.15	tol	= 0.2
d5 min	= 2.5	n abl x 1000	= 7	Tong	= ZGA-3
Description	= AV 60	s	= 2.00	Weight kg/1000	= 13.80
FN kN	= 23.00	Side power N at I2	= 4.5		